

USER MANUAL



Spray booth
Model: GL5

Company Introduction

About GuangLi

Guangzhou Guangli Electromechanical Facilities Engineering Co.,Ltd. is a professional spray booth and car lift manufacturer and the member of China Automobile Maintenance Equipment Association.Guangzhou Guangli was founded in February 1994,expanded a new factory in 2005,which cover areage of 58000 m2,,building area 36000m2,and have been completed in construction,and more,launched the production in 2007.

Our products have CE approved and our company has passed ISO9001:2000.The sales volume of spray booth ranks top in this field.

Guangzhou Guangli Electromechanical Facilities Engineering Co.,Ltd.is the first auto-spray booth manufacturer in China,the present largest spray booth maker in China and has a good reputation among Chinese auto-maintenance enterprices.

We have two brands,Guangli and Ritian,which are sold well in the domestic market and abroad over 20 countries.Guangli spray booth and lift have been approved and authorized by the following car manufacturers:Guangzhou Honda,Dongfeng Honda,FAW Toyota,Guangzhou Toyota,Dongfeng Peugeot,Dongfeng Citroen,Dongfeng Nissan,FAW Mazda,BMW South China,Chery Auto,Dongnan Auto,JAC Auto,MG,Hafei Auto,etc.

We respect quantity as our first belief.Guangli has invested much in machines,which make the components for spray booth and car lift modularized.

Guangli is endeavoring to develop itself and hopes we can work together with you for the bright future.



INDEX

Company Introduction.....	- I -
Chapter 1 The Description of the Spray Booth.....	- 1 -
1.1 The Struction Description.....	- 1 -
1.1.1 The Main Room.....	- 1 -
1.1.2 Generator Part.....	- 4 -
1.1.3 Control panel.....	- 5 -
1.1.4 Safety Thermosta.....	- 6 -
1.2 The principle of the spray booth.....	- 6 -
1.2.1 Spray Painting Phase.....	- 6 -
1.2.2 Drying Phase.....	- 7 -
1.4 Technical Parameter.....	- 8 -
Chapter 2 The Installation of the Spray Booth.....	- 9 -
2.1 The Installation Environmental Characteristics.....	- 9 -
2.2 Some Necessary Tools.....	- 10 -
2.3 Installation Methods and Steps.....	- 10 -
2.3.1 Basement installation.....	- 10 -
2.3.2 Generator Installation.....	- 12 -
2.3.3 Main room installation.....	- 14 -
2.3.4 Ceiling Installation.....	- 17 -
2.4 Control System Installation.....	- 19 -
Chapter 3 Test and Operation.....	- 22 -
3.1 Preparation Before.....	- 22 -
3.1.1 Preparation before testing and operation.....	- 22 -
3.1.2 Attention before testing and operation.....	- 22 -
3.1.3 Test the rotation of the blower.....	- 22 -
3.1.4Test the damper system.....	- 22 -
3.2 Attention Norms.....	- 22 -
3.3 Operation.....	- 23 -
3.3.1 Painting station.....	- 23 -
3.3.2 Drying station.....	- 24 -
3.3.3 Machine Stop.....	- 24 -
Chapter 4 Maintenance and Repair.....	- 25 -
4.1 Ordinary Maintenance.....	- 25 -
Appendix I : Malfunction and Remedy.....	- 26 -

Chapter 1 The Description of the Spray Booth

1.1 The Struction Description

The spray booth GL5 is composed of the following parts:(shown in Fig.1.1)

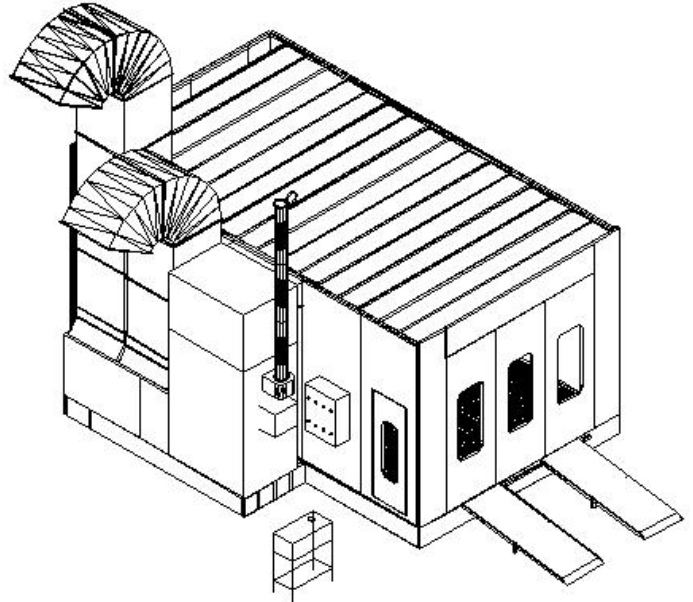

Fig. 1.1

1) The main room:

- The base parts: Side metal panel,Back metal panel,Front metal panel,Middle supporting,strengthen bar for basement,support net for filter,galvanization air block panel,floor filter grids,ramp for auto enter.
- The body parts: wall board,front door with (including horizontal board and stand board),safe door,surround pieces of wall board ect.
- The top parts(air cabint) : top sealed board,lighting frame,filter slot panel,supporting for the filter,roof supporter beam,filter,roof cover.

2) Generator parts

- Bottom of heat-air generator
- Middle frame of generator :including the intake fansr and heat exchanger
- Burner,diesel burn for standard model and gas burner for optional.
- Top-frame for generator、 the connection part between top frame and air cabint
- Damper for change between painting and baking system.
- Exhaust system: exhaust fan with pre-filter
- Smoke tube:connect with heat-exchanger,take the heat out.

3) Oil tank with frame

4) Control system: control the motor,burner,light system ect.

1.1.1 The Main Room

The spray painting environment is the closed place where the spray painting and the drying process is carried out. it is divided

into the following subgroups:

1) Side walls

The side walls are necessary to isolate the spray painting environment from the outside, both from the thermal and acoustic point of view, and above all so as not to disperse the paint and solvents residue into the environment, it is formed by: (shown in Fig.1.2)

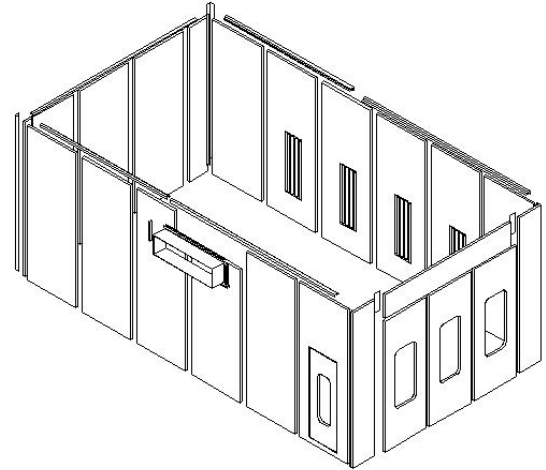

Fig 1.2

- Side walls made of panels, with a thickness of 50 mm, modular types with tongue and groove jointed, inserts with added seals. The thermic insulation of the spray painting environment is warranted by the layer of expanded polyurethane or rock wool contained in the panels.
- Back walls, panels made of the same type as the side walls.
- Metal covers up the wall, are necessary for the up cover of the walls, which make each panel connect together and easy to install the ceiling cover.
- Back corners, that are necessary for the connection between the side walls and the back wall.

2) Front walls

The front wall of the booth is composed of : (shown in Fig.1.3)

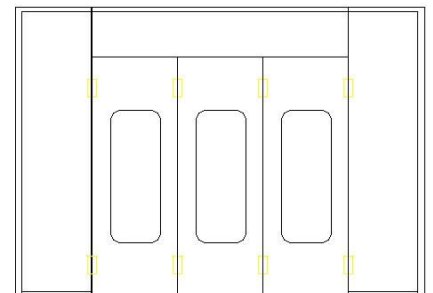

Fig. 1.3

- The header horizontal panel, is necessary for the plenum chamber and as a closure of the head part of the front wall.
- Maid door with the glass window, for the entry-exit of the operator, equipped with a spring release opening.
- Side erect panel, is necessary to support the maid door and connect to the side wall panel.
- The installed fitting parts: such as the door lock, handle, hinges, connection bar for horizontal panel and erect panel.

3) lumination system

- The internal illumination is warranted by the overhead lights (shown in Fig.1.4) inserted into the top of the side panels, positioned at an angle of 45° to warranty a sufficient and uniform illumination.



Fig. 1.4

- The overhead lights are steel plates coated in paint in which four neon holders are positioned, each of which feeds four neons of 36 W, the neons are isolated from the spray painting environment by panes of glass of the same type used for the doors.
- In order to reach the better illustration effect,we usual install the side light in the side wall, the neons are isolated from the spray painting environment by panes

4) Ceiling

The ceiling acts both as a cover for the spray painting environment and support for the air filters at the entrance, it is composed of: (shown in Fig.1.5)

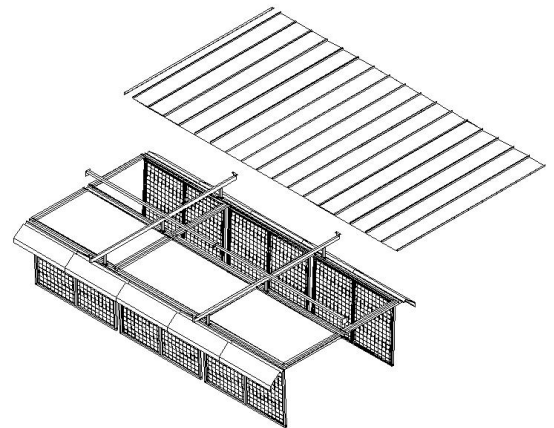

Fig. 1.5

- Top lights, contain the neons for the illumination of the booth, they are the parts of the air cabin.
- The filter frame, which are hanged with the top sealing panel.
- Roofs, they are plates of zinc plated that are necessary for the cover of the booth.
- The iron supporting beams, intercross by horizontal beams and longitudinal beams, which are used for supporting the ceiling.
- Top sealing panel, are installed on the supporting beams, they are necessary to cover the ceiling and hold up the filter frame

5) basement

The basement serves as a plenum chamber conducting the exiting air, from the booth. It is composed of (shown in Fig.1.6)

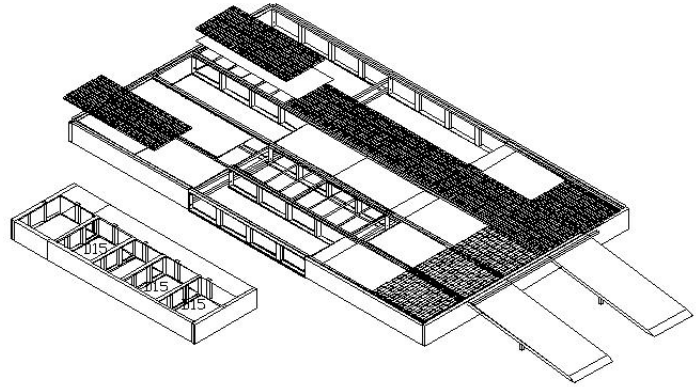

Fig. 1.6

- Basement, made of front panel,back panel,side panel,middle supportor and strengthen bar placed longitudinally and connected together. The pieces composing the basement are made of zincd pressure folded plates.
- Floor filter supported frame and panel placed under the filter,the side rows and middle row with the panel for keeping air off when all rows grids as optional. And the No 2 and No.4 rows with the supported frame for air ventination.
- Floor filter,is necessary for painting filtration.Usuallly cover row of No.2 and No.4 with the floor filter.And cover all five rows with floor filter when all grids as optional.
- Grids, that are inserted in the basement necessary for the flooring. There are five rows in total,Row 2 and Row Four should be the grids,and Row 1,Row 3 and Row 5 should be vein boards. but row No.2 and No.4 in the area in which the air is aspired the grids are only used, in order to allow the air to pass.

1.1.2 Generator Part

The generator unit is necessary to start the forced ventilation needed for an optimal aerification and a homogeneous distribution of the paint to produce the quantity of heat necessary for the drying process.All the components of the generator unit are to be found in a closed booth connected to the spray painting booth consisting of (shown in Fig.1.7)

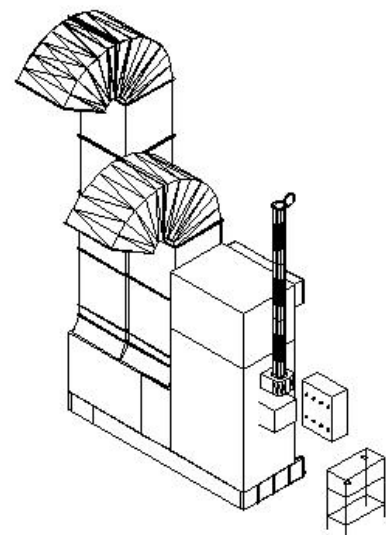

Fig. 1.7

- Connector, for the connection between the generator unit booth and the spray painting environment.Anti-vibration coupling in canvas is option so that the mechanical vibrations produced by the motor are not transmitted to their booth.
- Combustion room , equipped with a stainless steel heat changer and anti-exploding porthole as optional.

- Burner: Riello Diesel oil burner for standard. And the gas burner for option.
- Centrifugal fan , action by an electric motor.
- Enter filter frame, for pre-filtering incoming air.
- Damper system, which is pneumatic drive. it is necessary to a partially recycle the air to be introduced in the painting and drying process phase.
- Air duct: take the exhaust out of the working area.
- Chimney: take the exhaust heat out of the working area.

1. 1.3 Control panel

The control panel is composed of the following switches and indicators (Shown in Fig.1.8)



Fig. 1.8

- Switch to block main doors
- Light switch.
- Selector of Painting and drying process, allows the passage from the spray painting phase to the drying process and rise temperature painting.
- Break down alarm, it alarms if there are something wrong about the burner.
- Emergence stop button ,which can cut off the power when the emergence happen.
- Start button, press it when you want to start the fans.
- Power ON/OFF, turn the key when you want to start or close the power.
- Indicator, it indicates which of the parts are functioning.
- Temperature meter, it is necessary to regulate the temperature of the air both for the spray painting and drying process.
- Drying process Timer, it is necessary in order to regulate the drying process.
- Pressure meter, test the pressure difference between inside and outside of the booth.

1.1.4 Safety Thermosta

The safety thermostat (shown in Fig.1.9), placed in the generator group near the connector between generator and air canin of the booth (shown in Fig.1.10), the electrical power of the burner r will be cut off if the air flow reaches a temperature superior to 100°C



Fig. 1.9



Fig.1.10

1.2 The principle of the spray booth

The spray booth is in a dustproof closed environment in which a flow of air of the capacity and temperature necessary to make the booth function circulates. It works in two ways, one to carry out the spray painting phase/flash period and one for the drying phase. The pressure inside the booth is kept slightly greater than the atmospheric pressure (60mm H₂O), so that it can prevent the dust get into the booth during the operation.

1.2.1 Spray Painting Phase

During the painting phase, both the intaker fan and exhaust fan open, and the damper shutter place the position shown in Fig.1.11. The air capacity, aspirated from the outside by means of the generator fan is prefiltered passing through the pocket filters, heated to the desired temperature (about 20°C), and introduced into the plenum. Here an even distribution is obtained and there is a second filtration through the ceiling filter. After the filtration, the air crosses the booth from the top to the bottom part picking up the paint pigments and the solvents left by the spray painting, it is then aspirated by the exhaust air unit passing through the filters placed in the purification plant. (shown in Fig.1.11)

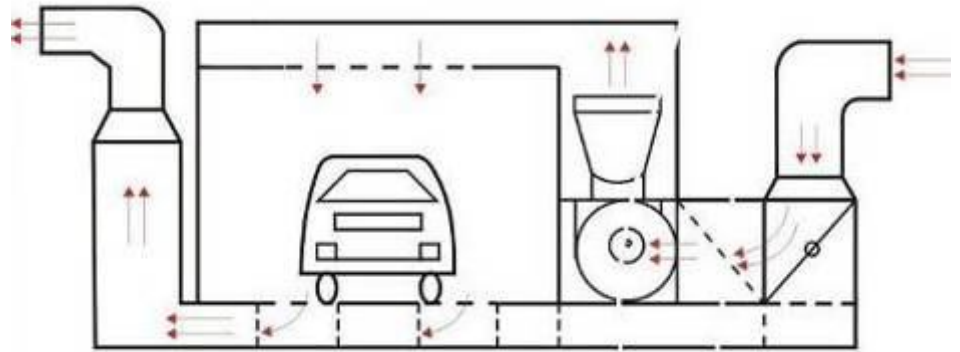

Fig. 1.11

1.2.2 Drying Phase

During the drying phase, exhaust fan will be turned off, the intake fan still operate, the damper change to the position shown in Fig.1.12. At the same time the burner start to operate, and supply the heating for the booth through the heat-exchanger, and enter into the internal cycle system. The ventilation style is similar to the painting phase, but the air through the basement will be taken into the intake fan again and form the internal cycle system. The temperature of the air has to be fixed according to the type of paint. Usually the set temperature should be 60°C

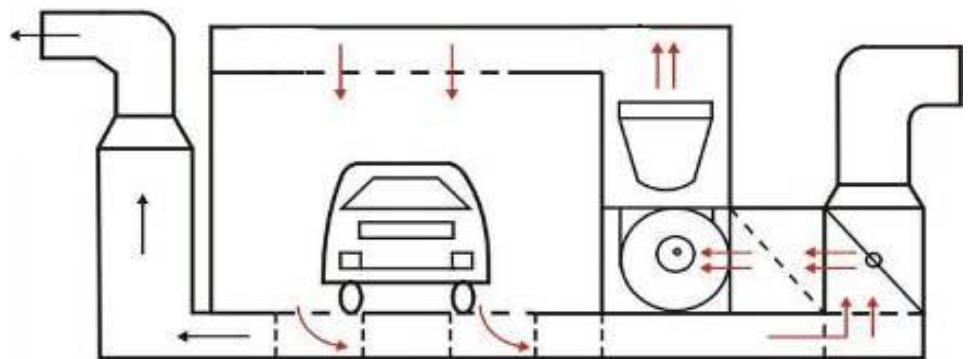

Fig. 1.12

1.4 Technical Parameter

Model		GL5
External Dimention (m)		7.0 × 5.3 × 3.5 (L×W×H)
Internal Dinmention (m)		6.9 × 3.9 × 2.7 (L×W×H)
Wall panel	Inside Material	Polystyrene(PE), Thickness: 50mm
	Structure	Colorful steel skin panel outside.Sanwich style.Tongue & Grove Joint
Front Door	Enter Size (m)	3.0 × 2.7 (W×H)
	Structure	3 folded sheet metal process without frame
Safe Door		One piece(1870×650mm)at in the side wall,with pressure lock
Light system	Top light	2 sides × 5 sets × 4 pcs 40W/ piece
	Side light	2 sides × 4 sets × 4 pcs 40W/ piece
Ceiling	Filter	Import filter,98%filtration rate.
	Structure	Hinge installed filter frame, iron welded, powder coating
Basement	Floor	All rows of grids
	Ramps	2 pcs of vein board style ramps
Generator	Intake Fan	1 × 11 kw Centrifugal fan with 1 pcs VCD adjustable damper
	Exhaust Fan	1 × 11 kw Centrifugal fan with 1 pcs VCD adjustable damper
	Intake Duct	4 pcs straight duct, 1 pcs 90° vent and 1 pcs 60° vent
	Exhaust Duct	4 pcs straight duct, 1 pcs 90° vent and 1 pcs 60° vent
	Fan Capacity	30000 M ³ /h
	Motor Voltage	380V/50HZ/3PH (Other voltage for option)
	Burner	Italian Riello diesel burner G20
	Heat exchange	Stainless Steel, Argon Arc Welding the heat exchange rate 80%
	Working Temperature	60~80°C
	Total Power	25 Kw
Electric Control system		Imported components,with Emergency stop, Breakdown alarm, Motor with Y/△ start style

Chapter 2 The Installation of the Spray Booth

2.1 The Installation Environmental Characteristics

Before beginning the assemblage work it is necessary to make sure that the environment where the booth is to be kept conforms with the characteristics below:

1. The electric power circuit has to be measured in order to ensure the correct function based on the installed power.
2. The face of the structure has to be smooth and leveled to warranty a perfect function
3. The support plan of the structure has to be of compact material, sufficiently resistant to bear the weight of the whole machine
4. For the correct function of the booth it is necessary that it has around it the minimum space as shown in Fig.2.1.
5. The pipeline system has to be predisposed to allow the influx of fuel to the burner.
6. it is necessary to ensure the exit of the emission pipelines and of the air extraction furthermore it is necessary that the ends of these two pipelines are positioned in such a way that the discharged air is not aspirated.

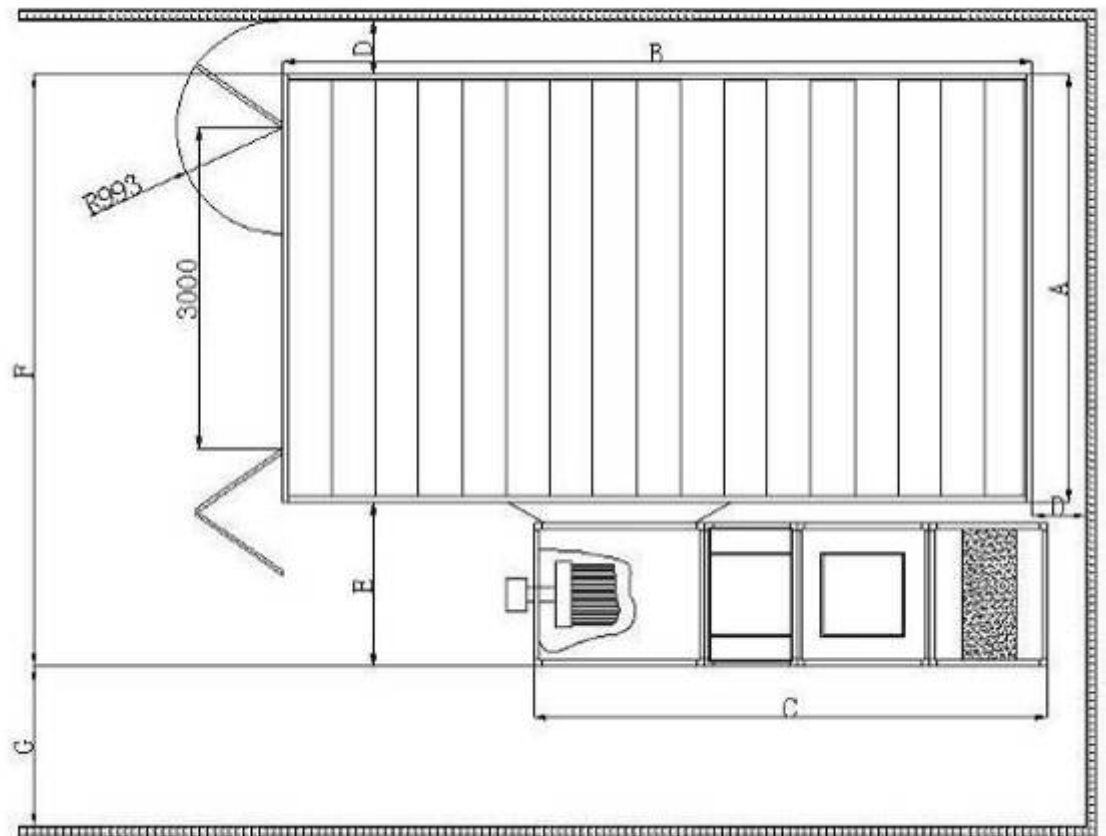

Fig. 2.1

DIM.INT.(mm)	A	B	C	D	E	F	G
6900x3900x2700	4000	7000	4050	500	1525	5555	1500

2.2 Some Necessary Tools

We will not offer the installation tools for the user,so you should prepare some necessary tools as shown Fig.2.2



Fig.2.2

2.3 Installation Methods and Steps

2.3.1 Basement installation

The basement installed step shown as the following step(shown in Fig.2.3)

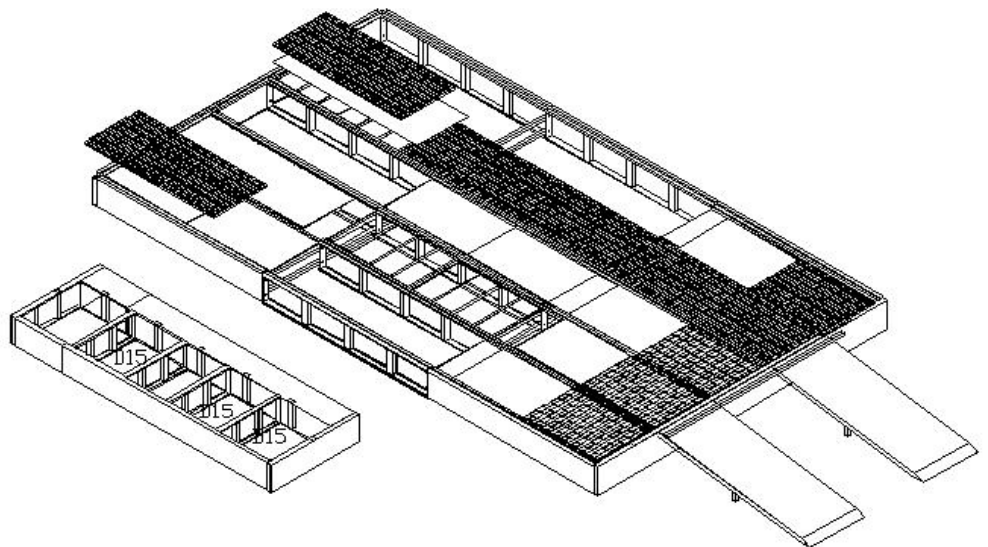

Fig. 2.3

1. Put the metal board(front,back,sides)and middle bracket in the right place,and connect them with bolt according to the demand of the installation chart.then screw down.
2. Adjust the level of the connect point: find the highest point with the level measure apparatus,then elevate other point with something.
3. Adjust the uprightness: adust the side boards and middle bracket with beeline,and distribute the distant between the rows,so that we can put the grids easily.
4. Check that all the longitudinal pieces have been mounted perfectly perpendicular to the end heads, to do this measure the two diagonals between the corner of the anterior end head and the opposite corner of the anterior end head, if they show the same values we are certain that it is assembled correctly. and the error value should be less than 5mm (shown in Fig.2.4).

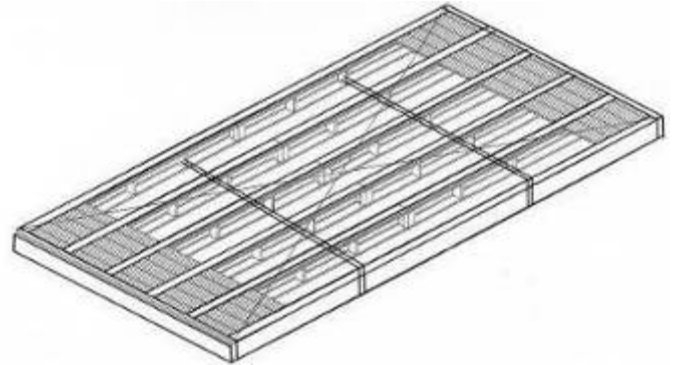

Fig. 2.4

5. Installate the bottom of the heat-air generator: the air out mouth should be connect with the metal sides board.(shown in Fig.2.5)

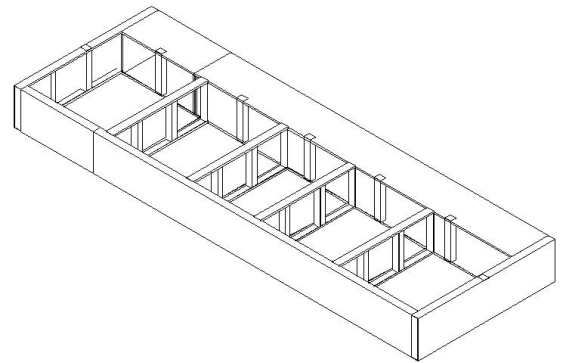

Fig. 2.5

6. Do some sealing for the basement.(shown in Fig.2.6)



Fig. 2.6

2.3.2 Generator Installation

1. Main part installation

The generator part is the main part of the spray booth, the separate part had been installed before delivery. Connect them together shown in Fig.2.7 is ok. Because the generator is heavy, you should pay attention to move them on to the basement (shown in Fig.2.7) Take with the Fork car would be better if you have (shown in Fig.2.8)



Fig. 2.7



Fig.2.8

2. VCD adjustable damper installation

The VCD adjustable damper is installed with the air enter and exhaust duct, which is used for adjust the air pressure inside and outside of the booth shown in Fig.2.9. Our standard model is manual control, shown in Fig.2.10. and the electrical control for option, shown in Fig.2.11.



Fig. 2.9



Fig.2.10

Fig.2.11

3. Duct installation.

Consider of the shipping space, the duct have not been installed, user should assemble them by yourself.

1) The straight duct installation shown in Fig.2.12

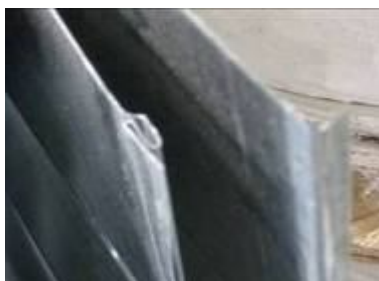

Fig. 2.12

2) The offset duct installation shown in Fig.2.13and Fig.2.14



Fig. 13



Fig. 2.14

3) The whole installation

Connection the straight duct and off with the clamps shown in Fig.2.15

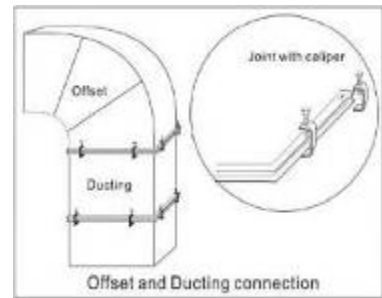

Fig.2.15

5.Chimney installation

The chimney should be connect to the fire outer of the heat-exchanger,and extent to outside.All the chimney had been assemble,you connect one by one is ok.(shown in Fig.2.16)

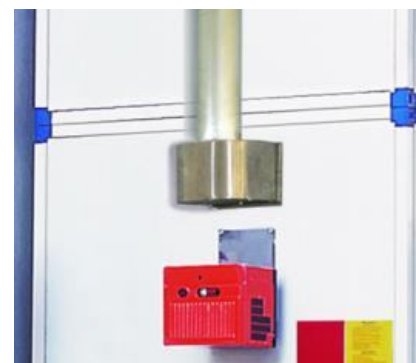

Fig. 2.16

2.3.3 Main room installation

1. Front door installation

Installate the front door frame(shown in Fig.2.17)

- 1) Put the left and right side panel on the ground,connect the the horizontal panel with the side panel.make sure that the gap should be smallest.



Fig. 2.17

- 2) Measure the diagonal of the length and width,when they are suitable for the demand of the door frame size (shown in Fig.2.18),fix the door frame with appoint connect board.Pay attention to that check the sizes of the door frame after fixing.

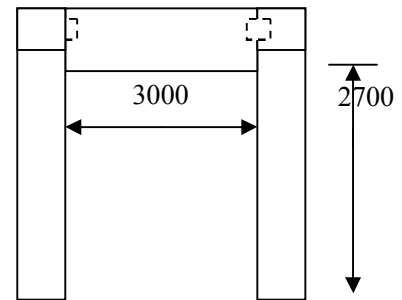

Fig. 2.18

- 3) Installate on the front metal panel of the basement and fix the vertical panel with bolts. (shown in Fig.2.19)



Fig. 2.19

- 4) Installate one wall panel at each side (one side with the personal door),connect them with the nail(show in Fig.2.20)

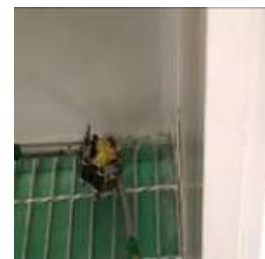

Fig. 2.20

2. Wall panel installation

1) connect the wall board in turn and fix the to the down U style slot with nail,make sure the gap should be smallest.Check the whole length of two sides wall board should be suit for the demand.(shown in Fig2.21)



Fig. 2.21

2)Intallate the back wall board ,pay attention to that the edges between back wall and sides wall should be angle to angle. (shown in Fig.2.22)

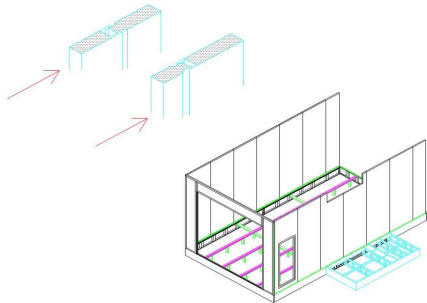

Fig. 2.22

3)Installate the edges inside and outside.(shown in Fig.2.23)

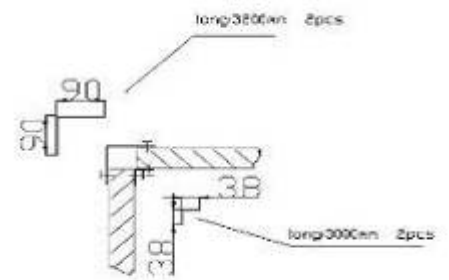

Fig. 2.23

4)Installate the cover of the wall panel(shown in Fig.2.24)



Fig. 2.24

5) Air enter connector installation

The air enter connector is necessary between the top frame of generator and air cabin.(shown in Fig.2.25) install the cover of the shorten panel,then connect to zinc panel with nail and do some sealing.

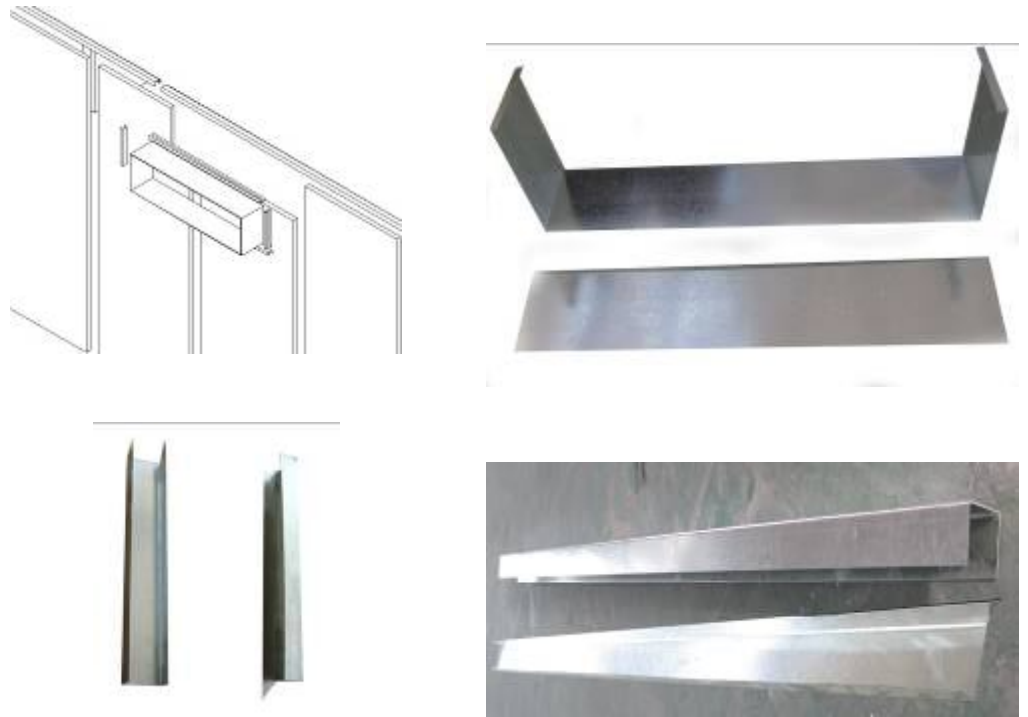

Fig. 2.25

4. Main door installation

Installate the door,including the lock,hinge,handle,plastic sealing bar and so on. (shown in Fig.2.26)

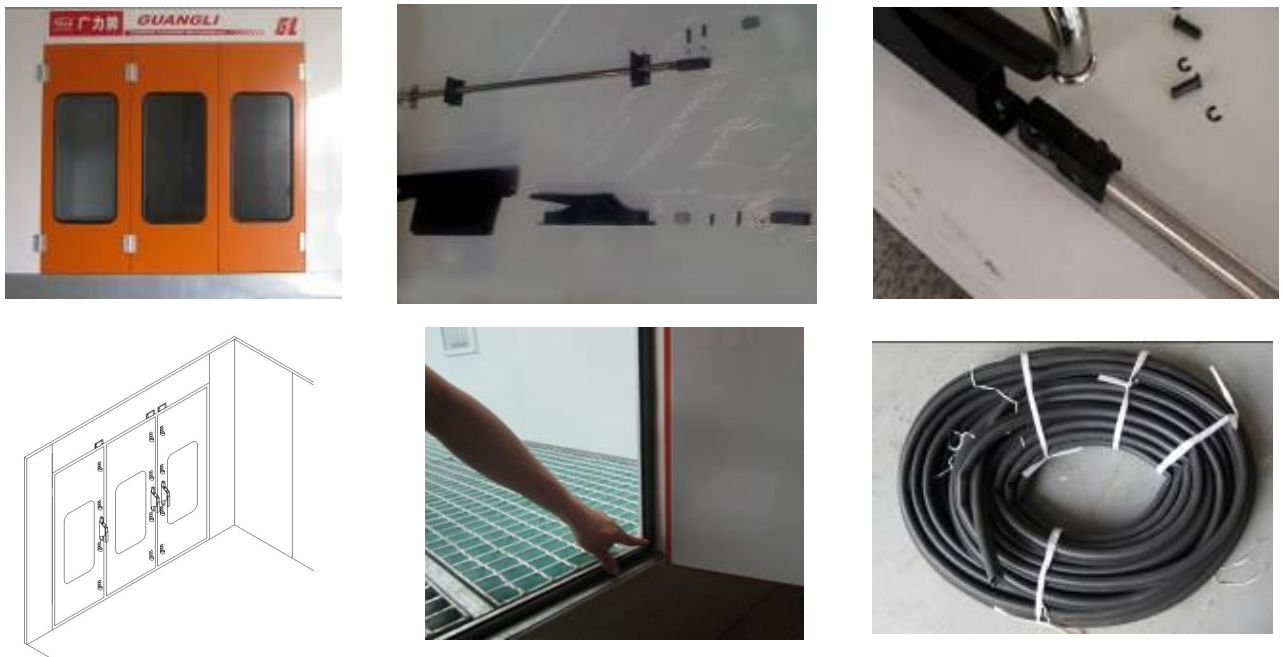

Fig. 2.26

5. Safety door installation

Safety door is necessary for protecting the worker's safety when they working inside the booth. When the pressure inside the booth is over large, the pressure lock of safety door will be open automatic. Install it shown in Fig.2.27. The pressure lock can be adjusted, not too tight and to loose is ok.



Fig. 2.27

2.3.4 Ceiling Installation

The ceiling shown in Fig.2.28

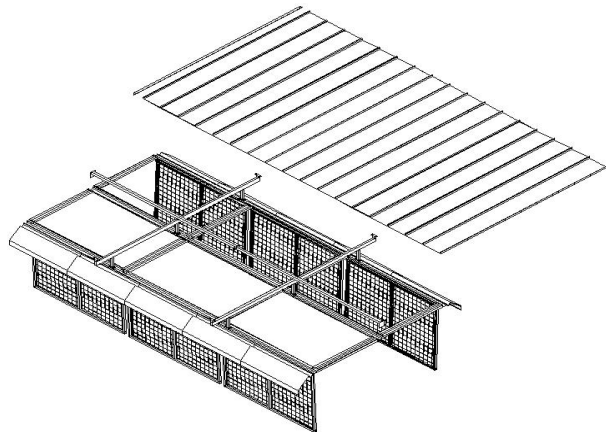

Fig. 2.28

1. Supportor beam installation (shown in Fig.2.29)

- 1) Installate the horizontal beam to the up rim of side wall panel with the bolt.
- 2) Installate the vertical beam to the front and back wall with nails.
- 3) Connect the horizontal and vertical beam together with the nails.



Fig. 2.29

2. Installate the top sealed board and cotton slot shown in Fig.2.30

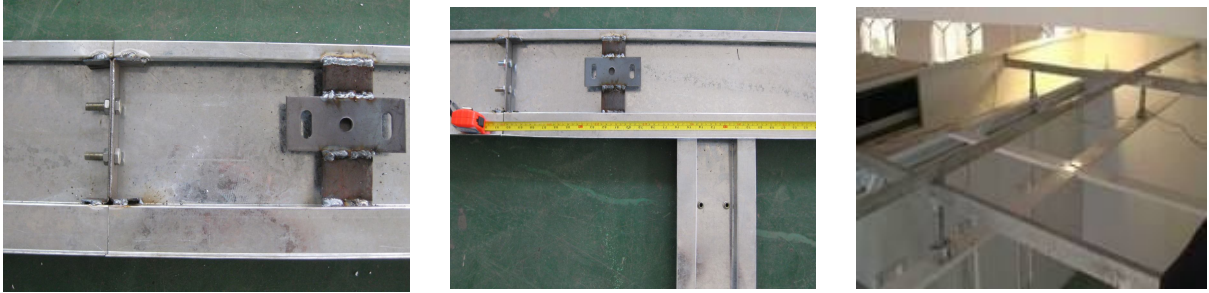

Fig. 2.30

3. Installate the light box and do some sealing with the transparent pastern shown in Fig.2.31



Fig. 2.31

4. Installate the roof cover and do some sealing with the transparent pastern shown in Fig.2.32



Fig. 2.32

5. Filter frame installation shown in Fig.2.33. Fix the filter on the frame with frame slot first,then installate the filter frame with the hinge.



Fig. 2.33

2. 4 Control System Installation

1. Control damper installation

The damper is exchanger between painting and baking system.the installation and test shown in Fig.2.34. Connect the air pile according the follow picture,and the air compressor should be prepared by user.The pressure should be set to 0.4~0.6Mpa as the pressure meter.Take the screw up and turn to adjust.



Fig.2.34

ATTENTION: There is a vane inside the damper shown in Fig.2.35.When the vane in the position A,that is the painting system,and when the vane in the position B,that is the baking system.You can test it when you are operation.If you find the wrong position,change the air pipe Port C and Port D shown in Fig.2.36 is ok.

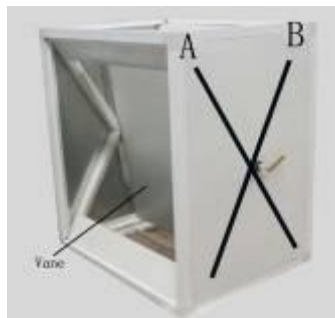

Fig. 2.35



Fig.2.36

2. Burner installation

1)Install the burner to the connection mounth of the heat-exchanger,then fix it with bolts shown in Fig.2.37



Fig. 2.37



2) Connect the burner and oil tank with the oil pipe, and don't forget to connect the oil cup, shown in Fig. 2.38.



Fig. 2.38

3. Temperature testing system installation

Install the temperature explorer at the middle of the ceiling inside the booth, and the wire connect to G port of the temperature meter directly through the ceiling air cabin shown in Fig. 2.39



Fig. 2.39

4. Compressure meter testing system installation

No loop for the pressure meter, just use one transparent air pipe insert one port of the meter, and another port of the meter should be plugged up. The other side of the air pipe should be put into the painting room through the ceiling air room. shown in Fig. 2.40



Fig. 2.40

5. The control box installation and wire connecting

1) Install the control box onto the wall panel near the generator shown in Fig. 2.41, and install the installation panel onto the wall with nail, then install the control box on to the panel.

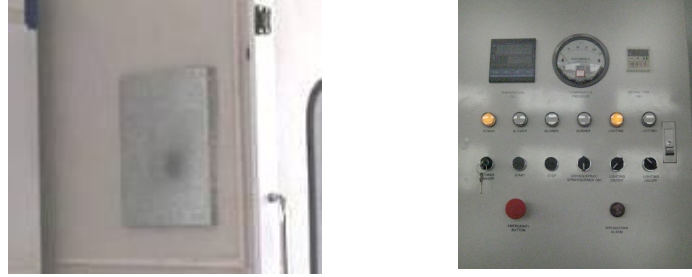

Fig. 2.41

2) Wire connection

The main component have been connected before delivery,the connection to the control box. you should do as follow in Fig.2.42: Connect the power supply into the control box and conect the control box to the burner,motor,light and control damper with electric wires according to the electrical chart we offer.



Fig. 2.42

Attention: You must connect the motor wire according to the electrical chart we offered.And you must be attention to the start method of the motor,Generally our spray booth have two start methods: motor direct start connection and Y/ Δ start connection.When you choose the motor direct start,The Up and Down ports of the motor should be connected with the metal pad, and then connect three ports (Up or Down) to the control box shown in fig. 2. 43. When choose Y/ Δ start connection, you must take the metal pad out, and connect to the six connection ports in the motor.

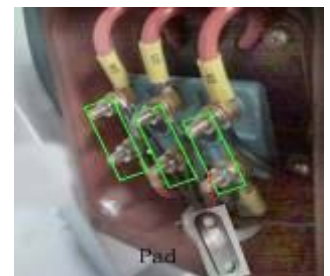

Fig. 2.43

Chapter 3 Test and Operation

3.1 Preparation Before

3.1.1 Preparation before testing and operation

- Prepare three phase electric power supply which is suitable for the motor connection.
- Prepare the air compressor for the control damper.
- Check the control system connection of the damper,the testing method as the chapter 3 mention.
- Prepare enough diesel oil in the oil tank.

3.1.2 Attention before testing and operation



- Check the connection of the electric chart according to the chart we offer.Make sure that you must ask someone who has the qualification of the electrical work.
- Check the connection of the diesel oil pile and the connector,the leakiness phenomenon is forbidden.
- Keep to all the signaling of danger and safety posted on the booth.
- The qualification of the personnel, The personnel employed to work on the booth, before beginning the work, has to have studied the "SAFETY " because during the work there will not be time. This is important above all for the personnel who only work sporadically.
- During the painting process,it is forbidden for the personnel to go into the booth, with non-regulation clothing (including necklaces, bracelets, rings etc.).

3.1.3 Test the rotation of the blower

- Intake blower testing:Open the pre-filter cabin in the generator and check the rotation of the fan,make sure the air can be taken in when the fan turn on.
- Exhaust blower testing:Take out the cover panel of the exhaust cabin,check the rotation of the fan,make sure the air can be taken out when the fan turn on.

3.1.4 Test the damper system

The main function of the damper is the transition between the painting system and baking system.the test method shown in Chaper two 2.4

3.2 Attention Norms



In the paragraphs below are listed all the regulations and prohibitions to be observed in order to prevent possible accidents:

- Prepare and keep paints in a place outside of the spray painting environment.
- Clean the inside surfaces of the oven and the glass of the overhead lights from possible paint residue or solvents.
- Use the spray paint gun correctly: spray only in the direction of the surfaces to be to painted, in order to keep the operator in clean air.
- Make sure that inside the vehicle there are not dangerous objects or substances.
- Make sure that the emergency exit is free of objects that may hinder the opening in emergency cases.
- Make sure that all the discharge air and smoke ducts are protected by the appropriate grates and that the air passage is not obstructed.



Inside the spray painting environment, it is **FORBIDDEN** as follows

- To introduce the vehicle to be painted without first removing the petrol tank and the battery.
- To smoke
- To use equipment that can produce sparks or flames and any kind of electric apparatus.
- To use incandescent objects.
- To paint when the temperature of the spray painting environment is more than of 30°C.
- To enter during the drying process phase.
- To use more than 150 g of paint for 1000 Nm³/h of air (corresponding to a max of 2. 7 Kg/h of paint)
- To keep objects or dangerous substances such as aerosol bombs, containers and solvents,
- To wear overalls or other garments dirty with paint residue or solvents.
- To have or consume food or drinks
- To climb on the roofing of the spray painting booth, the exhaust air runoff and the generator.

3.3 Operation

The spray booth has two working station:Painting station and drying station,the two station have been connected each other and have the different operation.And during low temperature environment in the winter,we should open the burner and rise the temperature about to20~25°C during the painting station.The control panel is shown if Fig.3.1



Fig. 3.1

3.3.1 Painting station

After having cleaned and prepared the vehicle, the operations functions for the painting phase as following steps.

1. Turn on the key switch to open the power supply, and press the light switch to turn on the lights
2. Drive the vehicle into the booth, and close the main door.
3. Check the setting value of temperature meter and drying timer, normally the value had been set by the manufacturer. And the drying temperature should be 60°C and the drying time should be about 30~45 minutes.

4. Check the shuff of the damper is in the right position
5. Press the motor button to open exhaust fan, and the intake fan start after about 8 seconds, and you can see the indicator of the motor turn on.
6. The worker get into the booth through the safety door and do the painting. If the temperature is low, turn the dring/painting switch to left and open the burner and rise the painting temperature.
7. The worker get out from the booth through the safety door when finish the painting. Then change to baking station.

3.3.2 Drying station

The operations to follow in the drying process phase are:

1. Make sure that all the spray painting functions are ended and that the operator has gone out of the spray painting environment.
2. Check there is enough diesel oil in the oil tank and no leaking of the oil pipe.
3. Check the setting value of temperature meter and dring timer, normally the value had been setted by the manufacture. And the dring temperature should be 60°C and the dring time should be about $30\sim 45^{\circ}\text{C}$.
4. Turn the dring/painting switch to right to open the burner. At the same time the damper will turn to another position and the light will turn off automatic. About 5~10s later, the exhaust fan will turn off, but the intake fan is keeping operation.
5. The spray booth will be working automatic till the setting dring time finished.
6. When the setting dring time is finished, the burner will stop automatic first, then the motor will stop about 5~10minute later.
7. The light will be turn on again after the motor stopping.

3.3.3 Machine Stop

To stop the booth before the foreseen time it is necessary to:

1. Turn the burner switch onto the OFF position (Middle position) .
2. Open the gate of the booth and let the vehicle out.
3. Switch off the lights if they are on
4. Turn the general switch onto the OFF position.
5. Wait for about 15 minutes in order to get the air condition inside the booth, then close the main doors.



ATTENTION: After drying, if there is more heating or exhaust air inside the booth, it is necessary to start again from the spray painting cycle in order to allow the reinstatement of the initial condition with an adequate ventilation.

Chapter 4 Maintenance and Repair

4.1 Ordinary Maintenance

Maintenance has to be a preventive and planned activity, seen as fundamental need to obtain safety, as a presupposition that the machines and the apparatus are subject to wear which is a potential cause of breakdowns. Therefore the safety of the booth depends also on a good preventive maintenance that allows the substitution of the objects subject to wear out before the verification of the technical faults.



Please carrying out the maintenance intervention /cleaning as the following ordinary maintenance and frequency verification instructions:

- Keep the booth clean and keep the intake and exhaust duct be open.
- Change the top filter after painting 200sets of auto or use more than one year, But in the more dust situation, that should be shorten the filter changed period according to the actual condition.
- Change the Pre-filter after painting 200sets of auto or use more than one year.
- Change the flour filter after painting 200sets of auto or use more than one year.
- Clean the filter oil cup and fire nozzle of the burner each week, keep the oil route be through.
- Add the diesel oil is forbidden when the burner is working.
- Make sure there are more than 5L oil in the oil tank, use Non diesel oil is forbidden.
- Check the filter net of the activated charcaod environmental cabinet after painting 20sets of auto or use more than 1 month. If the painting adhibit to the filter net full, change the filter net in time and keep the ventilation be through.
- Check the heat exchanger every two months, examine whether have the bad welded phenomena, make sure safety enough.
- Clean the dust adhered to the fans and blades semiyearly
- When you don't operate the booth for a long periods, cut off the general power, and open the door for ventilation every three days, in case accumulate the moisture air inside the booth.
- Change the heat exchanger and all of the electric wire when using more than 8 years.



Maintenance in time is necessary, but the appropriate maintenance is also very important, you should abide to the following mainly maintenance method and attention problem

Appendix I : Malfunction and Remedy

MALFUNCTIONING	PROBABLE CAUSE	REMEDY
The moter can not Start	<ol style="list-style-type: none"> 1. Fusing fault 2. Thermal relay in operation 3. The motor,wires circuit break 	<ol style="list-style-type: none"> 1. Change new fuse 2. Push button of thermal relay reposition 3. Change the moter and wires
The Capacity of the fan is small	<ol style="list-style-type: none"> 1.Pre-filter Jam 2.Damper have been right open or not open enough position 	<ol style="list-style-type: none"> 1.Clean or change the filter 2.Open the damper completely
Burner malfunction light turn on after the burner have started 20 seconds	<ol style="list-style-type: none"> 1. Use out of oil in the reservior 2. Oil pipe connector leakage 3. Too dirty in the filter net of the oil intake pipe 4. Electrical ege is too dirty 	<ol style="list-style-type: none"> 1. Add some diesel 2. Reconnect the pipe 3. Clean the fliter net 4. Clean the eletrical ege
The pump of burner does not start to work	<ol style="list-style-type: none"> 1. The pump strip is lock 2. The setted time have finish 3. The temperature valve have reach the setted valve 4. The burner is out of fuel 	<ol style="list-style-type: none"> 1. Check and clean the pump of the burner 2. Reset the time 3. Reset the temperature 4. Check the level of fuel in the reservior
Black smoke come out after the burner open	<ol style="list-style-type: none"> 1. The open position of burner damper is not enough 2. The pressure of pump is not enough 	<ol style="list-style-type: none"> 1. Adjust the damper more to more big position 2. Reset to the standard valve
Temperature rise is slow	<ol style="list-style-type: none"> 1.The damper is not close or not closed completely 	<ol style="list-style-type: none"> 1.Closed the damper completely
The lights do not work	<ol style="list-style-type: none"> 1. The fuses have blown 2. Ballast is interrupted 3. Connection ports loose 	<ol style="list-style-type: none"> 1. Replace the light fuses 2. Replace the ballast 3. Fix the connection ports
The pressure inside the booth is higher than usual	<ol style="list-style-type: none"> 1. The motor of the exhaust ir unit is off or not working regularly. 2. The extraction duct is obstructed 	<ol style="list-style-type: none"> 1. CheckThe exhaust air unit fuses Ensure the cable is connectyed to the motor and the the locks of the control panel 2. Check the filter of the basement or the exhaust air unit and replace them if necessary.
The pressure in the booth is lower than usual	<ol style="list-style-type: none"> 1.The motor of the generator is off or does not work regularly 2.The emission duct is obstructed 	<ol style="list-style-type: none"> 1.Check the generator fuses. Ensure the cable is connected the motor and the locks of the control panel. 2.Check there are not obstacles at the mouth of emission of the intake air unit.